

TNB-190LU1 BOX BRACKET

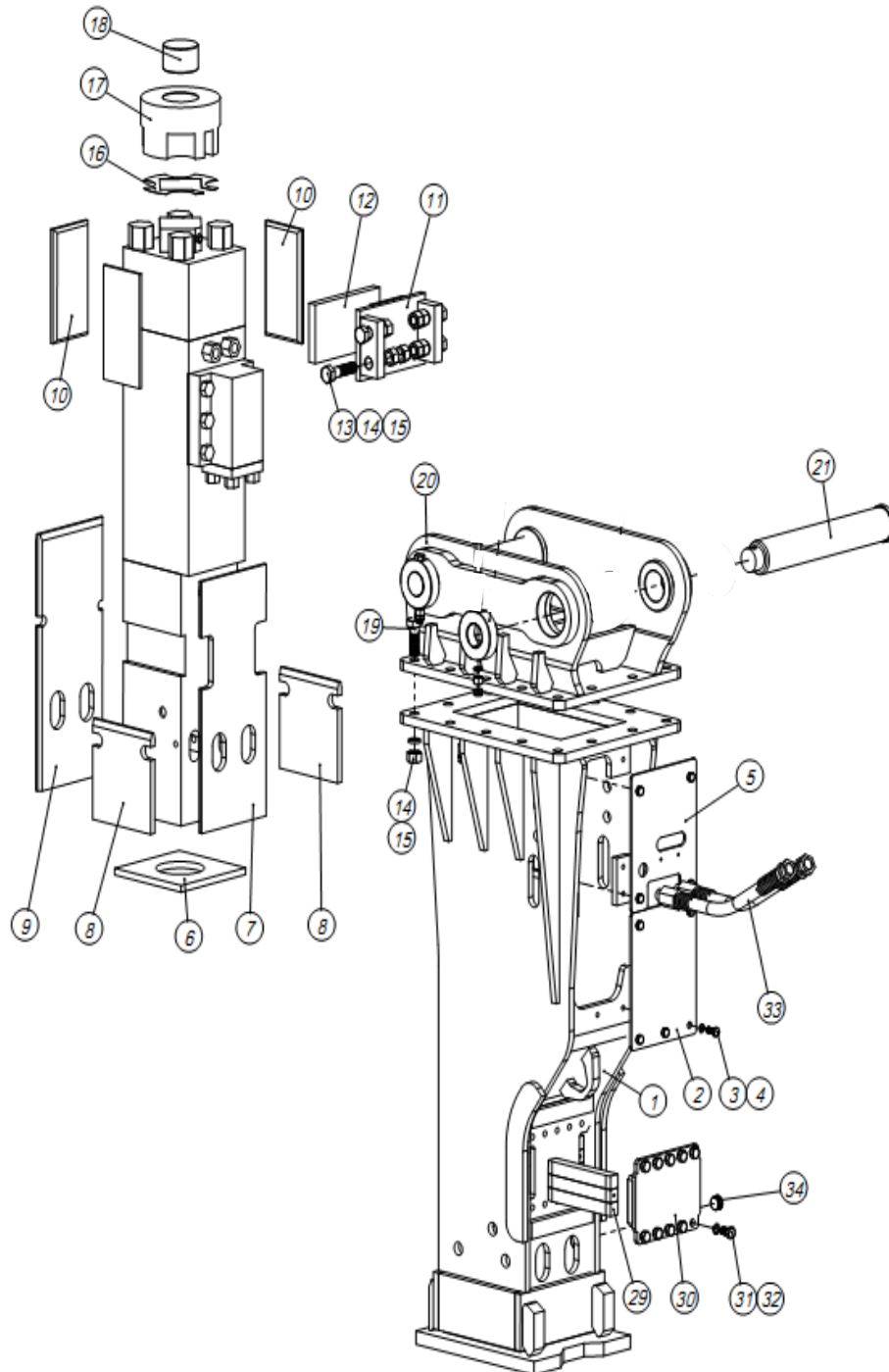

Parts

2018.06.01

No.1

Sym	Part Code	Description	Q'ty	Int	Kit
1	BKT-190LU1	BOX BRACKET CP	1		
2	190002	CONTROL VALVE PLATE	1		B
3	BLT-M16-35	H.T BOLT [M16x35]	9		B
4	WASHER-M16	SPRING WASHER [M16]	9		B
5	190005	GAS VALVE COVER PLATE	1		B
6	190006	UNDER SPACER	1		B
7	190007	CHISEL HOLDER SPACER	1		B
8	190008	SIDE SPACER	2		B
9	190009	BACK SPACER	1		B
10	190010	SMALL SPACER	3		B
11	190011	GUIDE PLATE	1		B
12	190012	GUIDE SPACER	1		B
13	BLT-M30-120	H.T BOLT [M30x120]	4		B
14	WASHER-M30	SPRING WASHER [M30]	18		B
15	NUT-M30	H.T NUT [M30]	22		B
16	190016	ADJUST MAT	1		B
17	190017	ISOLATOR TOP COVER	1		B
18	190018	NYLON POLE	1		B
19	BLT-M30-90	H.T BOLT [M30x90]	14		B
20	PER MACHINE MODEL	TOP CAP CP	1		
21	PER MACHINE MODEL	BRACKET PIN	2		T
29	190030	ASSEMBLED LOCALIZER	2		B
30	190032-2	COVER PLATE	1		B
31	WASHER-M20	SPRING WASHER [M20]	10		B
32	BLT-M20-35	H.T BOLT [M20x35]	10		B
33	SGH-2109	HOSE	2		
34	136096128	PIN PLUG ZG1 1-1/4"	1		B

Box Bracket CP consists of parts marked "B"

Top Cap consists of parts marked "T"

For Decal and/or Tool Box information, please contact your Dealer

INT(interchangeability)

- Interchangeable old ↔ new
- △ Interchangeable old → new
- ▲ Interchangeable old ← new
- × Not interchangeable